

Power MOS FET Relay

G3DZ

SSR Identical to the G6D in Size with a Maximum AC/DC Switching Current of 0.6 A

- Switching 0.6 A at 240 VAC or 100 VDC.
- 10- μ A current leakage max. between open output terminals.
- 2,500-VAC dielectric strength ensured between input and output terminals.
- Input resistor and varistor incorporated models available.
- Switching full- and half-wave rectified alternating currents.
- Approved by UL and CSA.



Ordering Information

Contact form	Insulation	Zero cross function	Indicator	Applicable output load	Rated input voltage	Model
SPST-NO	Photo-voltage coupler	No	No	0.6 A at 3 to 264 VAC 3 to 125 VDC	5 VDC 12 VDC 24 VDC	G3DZ-2R6PL

■ Accessories (Order Separately)

See *Dimensions* for details.

Connecting socket	P6D-04P
-------------------	---------

Specifications

■ Ratings

Input

Rated voltage	Operating voltage	Input impedance	Voltage level	
			Must operate	Must release
5 VDC	4 to 6 VDC	830 Ω ±20%	4 VDC max.	1 VDC min.
12 VDC	9.6 to 14.4 VDC	2 k Ω ±20%	9.6 VDC max.	
24 VDC	19.2 to 28.8 VDC	4 k Ω ±20%	19.2 VDC max.	

Output

Rated voltage	Load voltage	Load current	Inrush current
5 to 240 VAC, 5 to 100 VDC	3 to 264 VAC, 3 to 125 VDC	100 μ A to 0.6 A	6 A (10 ms)

■ Characteristics

Operate time (see note)	6 ms max.
Release time (see note)	10 ms max.
Output ON-resistance (see note)	2.4 Ω max.
Leakage current	10 μ A max. (at 125 VDC)
Insulation resistance	100 M Ω min. (at 500 VDC)
Dielectric strength	2,500 VAC, 50/60 Hz for 1 min between input and output
Vibration resistance	Malfunction: 10 to 55 Hz, 1.5-mm double amplitude
Shock resistance	Malfunction: 1,000 m/s ²
Ambient temperature	Operating: -30°C to 85°C (with no icing or condensation) Storage: -30°C to 100°C (with no icing or condensation)
Approved standards	UL508 File No.E64562 CSA C22.2 (No.14) File No. LR35535
Ambient humidity	Operating: 45% to 85%
Weight	Approx. 3.1 g

Note: These values are under the measurement conditions whereby rated voltages are applied to the input.

Engineering Data

Load Current vs. Ambient Temperature Characteristics

G3DZ-2R6PL

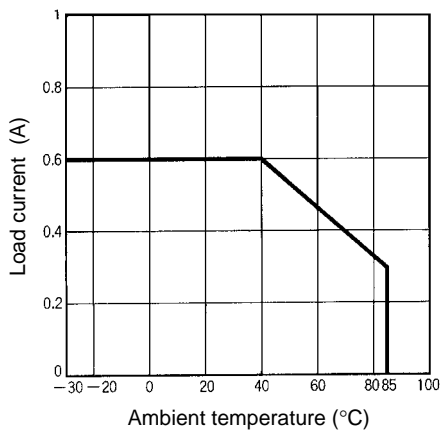

Inrush Current Resistivity

Non-repetitive (Keep the inrush current to half the rated value if it occurs repetitively.)

G3DZ-2R6PL

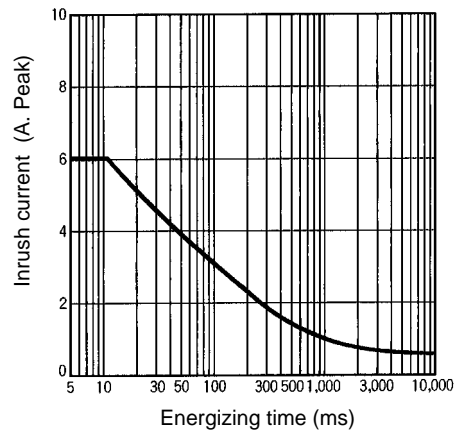

Dimensions

Note: 1. All units are in millimeters unless otherwise indicated.

2. Orientation marks are indicated as follows:

G3DZ-2R6PL

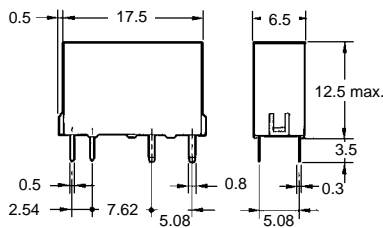
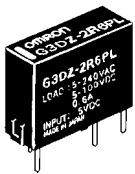

Mounting Holes (Bottom View)

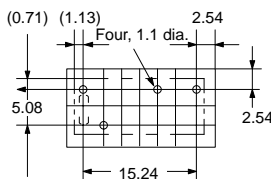

Terminal Arrangement/ Internal Connections (Bottom View)

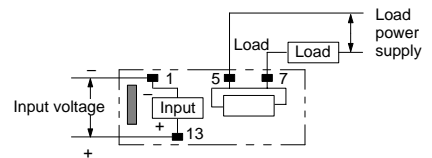

P6D-04P Connecting Socket

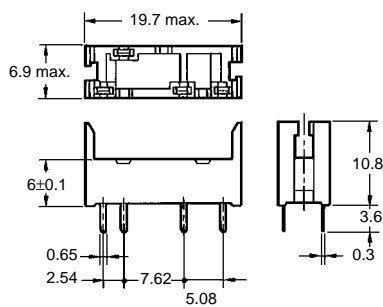
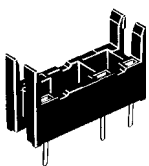

Mounting Holes (Bottom View)

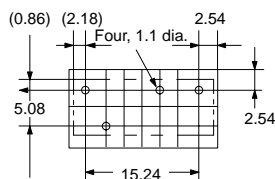

Socket Mounting Height

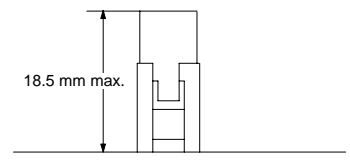

Precautions

If any reversed surge voltage is imposed on the input terminals, insert a diode in parallel to the input terminals as shown in the following circuit diagram and do not impose a reversed voltage value of 3 V or more.

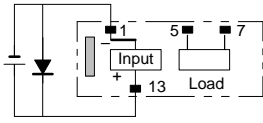

Terminals

Since terminals are made of materials with high heat conduction, complete soldering (automatic or manual) within 10 seconds at a temperature of 260°C.

When fitting with a Socket, match properly and push straight down vertically.

ALL DIMENSIONS SHOWN ARE IN MILLIMETERS.

To convert millimeters into inches, multiply by 0.03937. To convert grams into ounces, multiply by 0.03527.